

## HD Video Matrix Switching



### The Insider's Guide to HD Video Matrix Switching

- Explore video standards and how they are changing.
- Understand how matrix switching works, and its benefits.
- Learn more about HDMI, HDCP, and EDID/DDC.

## Table of Contents

Introduction.....	3
HD Video Matrix Switching .....	4
What is a Matrix Switch?.....	4
Matrix switching applications .....	4
Matrix control .....	4
Video standards.....	5
VGA.....	5
Digital video interface (DVI).....	5
High-definition multimedia interface (HDMI).....	5
EDID/DDC.....	6
HDCP.....	7
Audio and control switching .....	8
Separate audio.....	8
Embedded audio.....	8
IR switching .....	9
RS-232 switching .....	10
HDBaseT Extension.....	11
Video.....	11
Audio.....	11
Ethernet.....	11
Control .....	11
Power .....	11
HDBaseT .....	12
Matrix Switching and Video Extension: Choosing the Right Technology .....	12

We're here to help! If you have any questions about your application, our products, or this white paper, contact Black Box Tech Support at **724-746-5500** or go to **blackbox.com** and click on "Talk to Black Box." You'll be live with one of our technical experts in less than 60 seconds.

## Introduction

The way a user chooses to configure a matrix switch or extension setup depends on the application. Because of their scalability and flexibility, matrix switches work in any number of video extension applications, from small businesses, healthcare, and finance, to classrooms and corporate boardrooms, all the way to control rooms and broadcasting studios. A number of technology factors also need to be weighed: What kind of video is being extended? How will resolutions be reproduced, and through what channel is extended display identification (EDID) delivered? Is audio embedded in the video signal or not?

The following white paper examines video standards, data display options, and other factors to help users choose matrix switching and extension configurations.

## What is a matrix switch?

A video matrix switch, also called a crosspoint switch, is a type of switch that connects multiple inputs to multiple outputs in a matrix, or crossbar, manner. It can be configured to switch any number of inputs and outputs. Each input on the switch can be routed to any output source or receiver, or the same input can be routed to all outputs, or any combination in between. For example, an 8 x 8 matrix switch can route 8 inputs to 8 outputs, 1 input to 8 outputs, or any combination up to 8. This eliminates the need to manually move cables to display video from different sources on different screens. It is most commonly used now with HDMI video.

## Matrix switching applications

Because of its scalability and flexibility, matrix switching is an excellent fit for venues where multiple high-definition displays must be managed: corporate theaters, meeting rooms, classrooms, and broadcasting studios. When used with digital signage, a matrix switch enables you to quickly switch a display from one digital signage player to another.

## Matrix control

Matrix switches are controlled in a number of ways: front panel button control; infrared (IR) remote control; RS-232, or serial, external control; control via TCP/IP network.

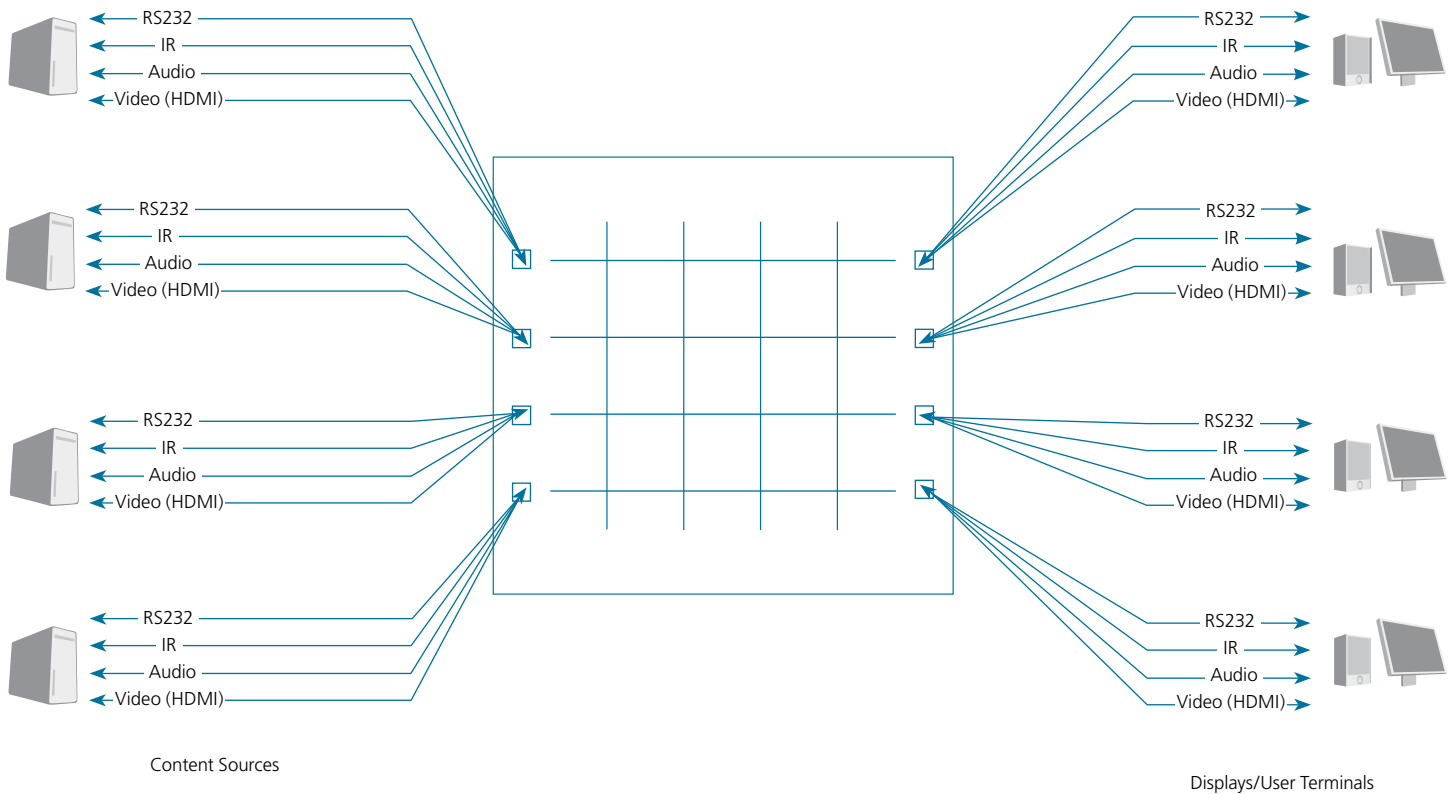

## Video Standards

### Analog video (VGA)

An analog signal is continuously variable. Composite video, Component video, RGBHV, and VGA are types of analog video signals. Until recently, VGA was the most common video format used with PCs. By 2015, the VGA connection standard will be gone.

An analog video signal can be run over long lengths of native VGA cable as long as the diameter and shielding of the cable is good enough. However, regardless of the cable quality, signal attenuation increases with video frequency and cable length. This means that after 30 to 50 feet, the image quality will start to degrade. This leads to color skew and smeared-looking text.

To solve for signal degradation in VGA applications, use an extender that compensates for signal loss. A good extender has separate adjustments for high and low frequencies; HF loss is usually greater than LF loss.

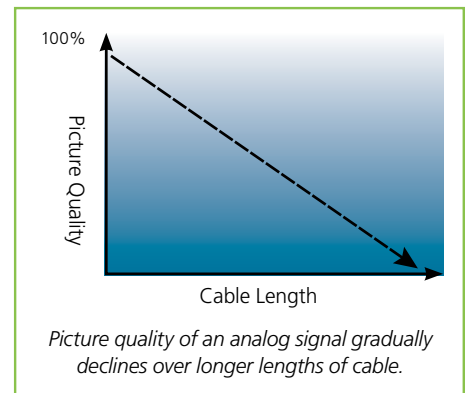

### Digital video

While analog video signals travel in a sine-like wave form, digital signals travel in a square-like waveform. A digital signal is broken into a binary format where the audio or video data is represented by a series of 1s and 0s. Like analog signals, digital video also suffers from loss, but as long as the cable is of sufficient quality and within the maximum supported distance, the signals don't suffer from blurring or color skew. HDMI and DVI (explained below) are examples of typical digital video interfaces.

However, what you will get when the maximum supported cable length is exceeded is the "cliff" effect, where the digital signal drops off and you completely lose the picture. To overcome distance limitations, you need to use extenders or repeaters.

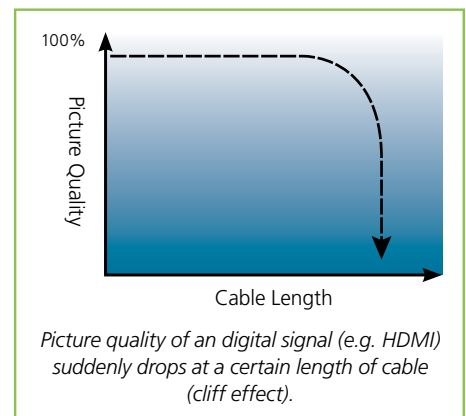

## DVI and HDMI Interfaces

### Digital video interface (DVI)

DVI is the standard digital interface for PCs.

The DVI standard is based on transition-minimized differential signaling (TMDS). DVI comes in two formats: single-link and dual-link. Single-link DVI has a maximum frequency of 165 MHz, and dual-link DVI, as you would expect, has double the maximum frequency. A single-link interface can transmit a resolution of 1920 x 1200 vs. 2560 x 1600 for dual link.

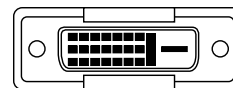

DVI-D Receptacle Connector

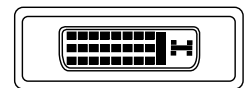

DVI-I Receptacle Connector

The most common DVI connectors are:

- DVI-D: A digital-only connector for use between a digital video source and monitors. DVI-D eliminates the analog pins.
- DVI-I (integrated): Supports both digital and analog RGB connections. It can transmit either a digital-to-digital signal or an analog-to-analog signal. It is used on products instead of separate analog and digital connectors.

### High-definition multimedia interface (HDMI)

HDMI® is the standard digital interface for HDTV. It was the first digital interface to combine uncompressed HD video, up to eight channels of uncompressed digital audio, and intelligent format and command data in a single cable. It is now the de facto standard for consumer electronics and HD video, although it is beginning to face competition from the newer DisplayPort (DP) interface. In addition, HDMI also uses TMDS signaling, like DVI, and is backward compatible.



HDMI Receptacle Connector

HDMI offers an easy, standardized way to set up AV equipment over one cable. Use it to connect equipment such as digital signage players, set-top boxes, and AV receivers with HDTVs and video projectors. If the HDMI equipment supports higher-resolution HDMI standards, you can also connect 3D displays.

HDMI also supports multiple audio formats from standard stereo to multichannel surround sound. In addition, the interface provides two-way communications between the video source and HDTV, enabling simple, remote, point-and-click configurations.

It also supports high-bandwidth digital content protection (HDCP), which prevents distribution and copying of digital audio and video content sent over HDMI cable. If you have a device between the source and the display that supports HDMI but not HDCP, your transmission won't work if the content is copyright protected.

HDMI is backward compatible with DVI equipment because, like DVI, it uses TMDS signaling. A DVI-to-HDMI adapter can be used without a loss of video quality to enable the connection. Because DVI only supports video signals, not audio, the DVI device simply ignores the extra audio data. However, dual link is not common in HDMI. DVI displays usually also are not able to display HDCP protected and/or component encoded (YCbCr) HDMI signals.

## EDID/DDC

Extended display identification data (EDID) is a data format standard determined by Video Electronics Standards Association (VESA). EDID contains basic information about a monitor and its display capabilities. The information is stored in the display and is used to communicate with the system through a Display Data Channel (DDC), which sits between the monitor and the graphics adapter. EDID/DDC is used to configure the system so the monitor and system can work together.

### Static EDID

Most switches come with one or more built-in EDID modes. Using a built-in mode will ignore the actual EDID from the displays, and the video source will output whatever the EDID from the switch is telling it. Using the above example, if the static EDID of the switch is selectable, it should be set to 720p to ensure compatibility with both displays.



EDID from switch only.

### EDID copy/learning

Most newer switches support manual EDID copy. This enables the user to manually select which EDID from which display should be used.

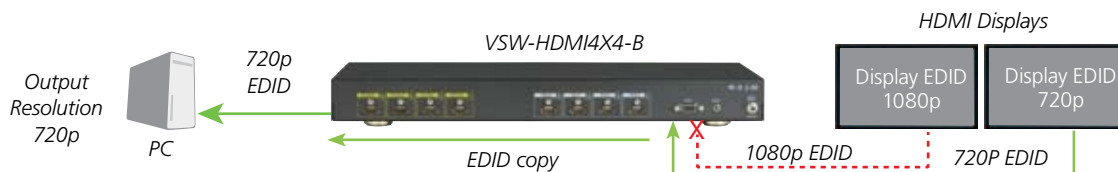

EDID copy: Choose EDID from display.

## Auto EDID

Some of the newer matrix switches on the market now support a more intelligent EDID handling that automates the job previously requiring the user to look through the specs of all monitors and perform a manual copy of the EDID. The auto mode enables the switch to analyze the EDID from all attached monitors, then pick the highest common denominator and feed this back to the source. This job is performed within milliseconds, and the switch can be set up to do this every time the source is switched to a new display to ensure that all connected displays will be able to display the video at all times.

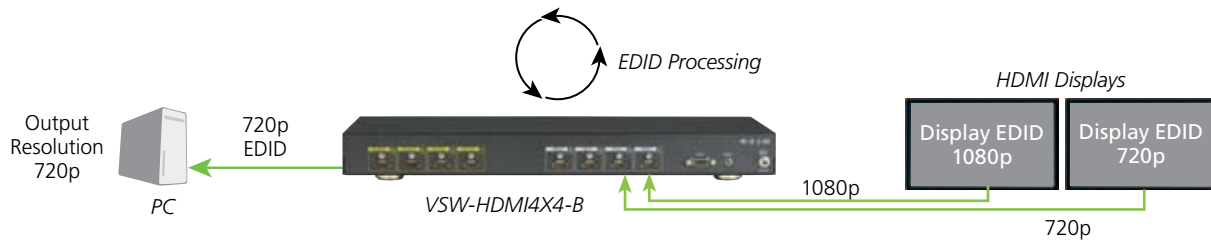

**Auto EDID: Switch analyzes and chooses EDID from displays.**

## HDMI and DVI incompatibility

Many resources claim the only major compatibility issues between HDMI and DVI are related to HDCP and audio; however, this is not correct. A common cause of HDMI headaches is the color encoding of the video.

PC video signals were traditionally encoded using RGB (Red — Green — Blue) color space, while video signals have been using component color (YCbCr). Y is the luma component and Cb and Cr are the blue-difference and red-difference chroma components. Although HDMI displays do not support RGB colors, most displays have an EDID that specifies YCbCr (component color) as default color encoding. However, DVI devices will, in most cases, only support RGB colors. If a video source is being routed to DVI and HDMI displays at the same time, the DVI displays will not be able to show the picture correctly if it is encoded in YCbCr. Common results are either a black screen or a strong green or pink color tint.

Whenever these kinds of issues in matrix switch applications arise, the best solution is to copy the EDID from a DVI display. This ensures the EDID table specifies RGB colors — which is supported by all displays.

## HDCP

High-Bandwidth Digital Content Protection (HDCP) is a form of digital copy protection and rights management developed by the Intel Corporation. It was developed to prevent digital audio and video from being copied as it traveled from source to display. The system is meant to prevent HDCP-encrypted content from being displayed on unauthorized devices or devices that have been modified to copy HDCP content. A transmitter "checks" that the receiver is authorized to play its content, then encrypts it to prevent it from being copied over the connection.

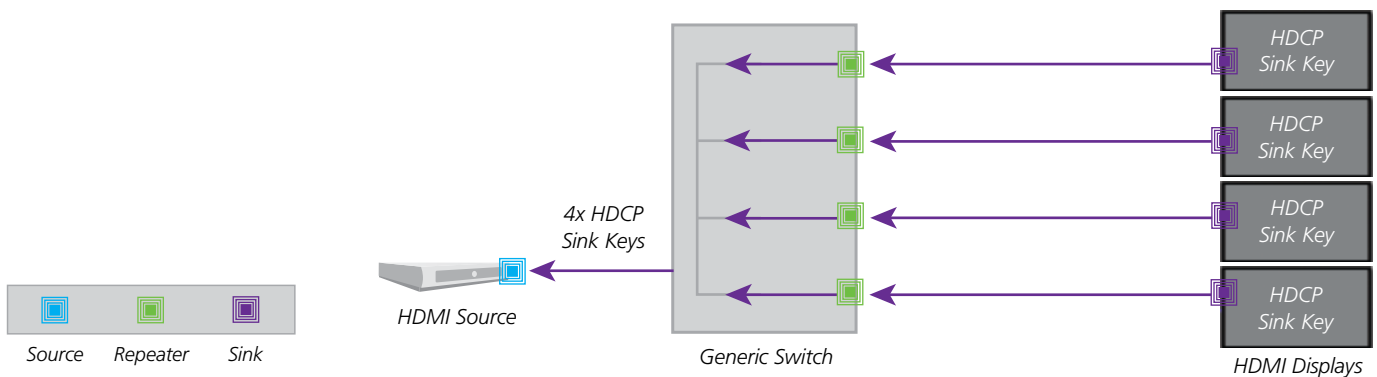

The conventional way of handling HDCP is by using repeater keys. All the unique HDCP keys of the display will be passed back to the source. HDMI sources only support a limited number of keys and some sources only accept a single key, which potentially means that the signal can only be distributed to a single display at time. Also if a non-HDCP compliant display, such as a DVI display, is switched to the source, the video will immediately be cut and all displays will go black.

The solution to this is to use a switch with its own HDCP keys on each of the outputs. By doing this the switch outputs now act as video sources and authenticate each of the displays separately, and the video source only needs to authenticate with the matrix switch input. If one of the displays is not HDCP compliant, the video to this single display can be cut without affecting the rest of the system.

This ensures a faster and more reliable matrix switch, which will be compatible with all types of HDMI sources.

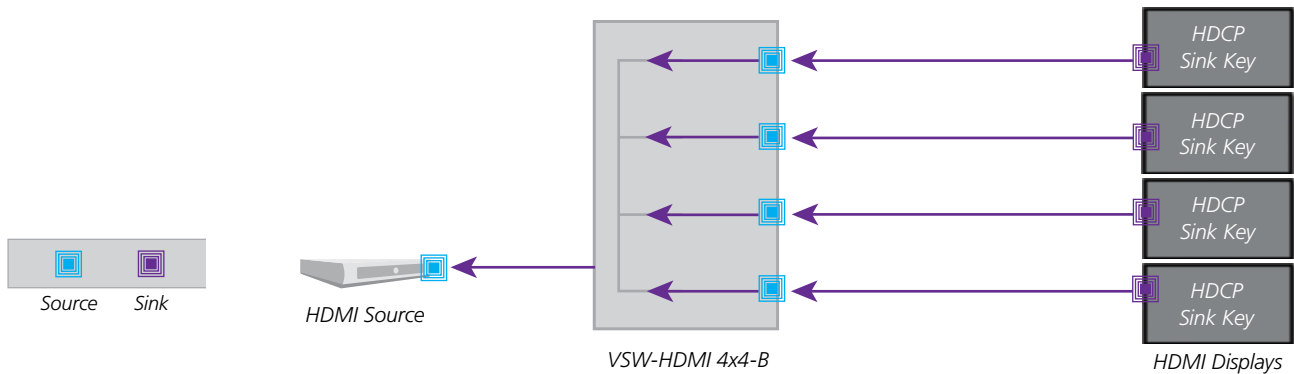

## Audio and control switching

### Embedded audio

HDMI supports embedded digital audio, allowing up to eight channels of uncompressed digital audio at sample sizes of up to 24-bit and sample rates of up to 192 kHz. From version 1.3 on up, it also supports Dolby TrueHD and DTS-HD Master Audio. This means the audio signal will always follow the video. Switches with embedded HDMI audio support only work for HDMI, but such a solution will not be backwards compatible with DVI, since DVI requires a separate audio input.

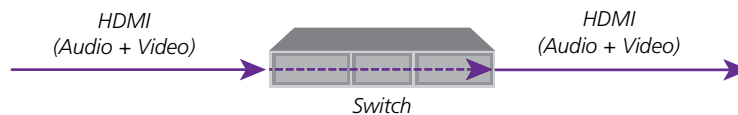

### Separate audio

Switches with separate audio I/O routes the audio separately from the video signal. This is the most common method of audio support for VGA and DVI switches. DVI sources have to use separate connectors for audio, usually a 3.5-mm mini jack for analog stereo audio, or S/PDIF or TOSLINK for digital audio. However, these solutions are not compatible with HDMI and make it impossible to mix HDMI and DVI devices with audio in the same switch.

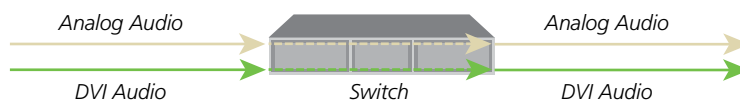



## Embedded audio with mixing

This is the preferred way of supporting audio in a matrix switch since this ensures backwards compatibility with DVI, and also enables audio to be extracted from the HDMI signal and sent to an external audio mixer or amplifier. The audio can be input separately on either a 3.5-mm connector for analog audio, or S/PDIF or TOSLINK for digital, or it can come from an HDMI source with embedded audio. Audio coming from a separate input will then be embedded into the HDMI signal and can be routed to an HDMI compatible TV or surround receiver, or it can be extracted from the HDMI signal again in case it is required as a separate output.

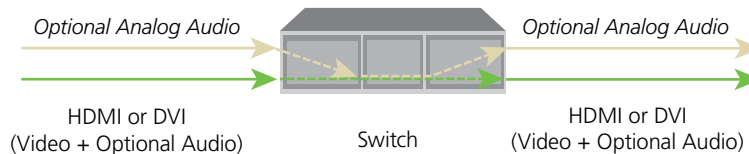

## IR switching

Infrared (IR) remote controls are used to control different kinds of equipment, such as Blu-ray players, set-top boxes, or TVs. The challenge with IR signals is that they require free line of sight and have distance limitations. When using a matrix switch, a device such as a Blu-ray player might be back-racked in an equipment room, and not within line of sight. In order to control such a device from a remote display, the IR signal has to be routed and extended through the switch alongside the video signal. This can be done by using an IR extender consisting of a receiver module and a transmitter module plugged into the switch. The IR "eye" (receiver) is placed by the display and receives the signal from the remote control. This signal is then transmitted to the switch and routed to the correct source and into an IR transmitter placed in front of the Blu-ray player. This transmitter module will then transmit the signal to the Blu-ray player.

In order to also transmit IR signals in the opposite direction (from the source to the display) bi-directional IR is required and the switch needs a second IR port.

One limitation to be aware of when doing IR extension and switching is that most extenders are limited to 38-kHz IR signals. This works with 90 percent of the devices on the market, but a few IR devices use 57-kHz frequencies and will not work through a matrix switch.

## RS-232 switching

RS-232 is a serial interface for asynchronous data communication. In professional audio-visual (ProAV) environments, this may be used to turn a display on or off, or to change inputs. RS-232 usually uses DB9 connectors, but can also use RJ-11, terminal block, or, in some cases, mini-jack. RS-232 is increasingly being replaced with Ethernet or USB interfaces for control functions. The required signals for basic operation are receiver (Rx), transmitter (Tx), and ground (GND), but some serial devices also rely on additional control signals. These control signals are not always supported by matrix switches, which could potentially cause problems.

RS-232 can be a bit tricky to work with since there are two types of RS-232 ports: Data Terminal Equipment (DTE) and Data Communication Equipment (DCE). The signal names and pin numbers are the same, but signal flow is opposite. A pin labeled Tx can be input or output, depending on whether it's a DTE or a DCE device.

The two ports types are complementary; the output signals on a DTE port are inputs to a DCE port, and output signals on a DCE port are inputs to a DTE port. A computer would typically be a DTE device, while communication devices like modems would be a DCE. However, displays are often DTE type devices (just like a PC) and will require a cross-pinned (null modem) cable when connected directly to a PC.

### Modem Cable-Straight Cable, DB9 to DB9

DTE Device (Computer)	DB9	DTE to DCE Connections	DCE Device (Modem)	DB9
Pin# DB9 RS-232 Signal Names		Signal Direction	Pin# DB9 RS-232 Signal Names	
#1 Carrier Detector (DCD)	CD	←	#1 Carrier Detector (DCD)	CD
#2 Receive Data (Rx)	RD	←	#2 Receive Data (Rx)	RD
#3 Transmit Data (Tx)	TD	→	#3 Transmit Data (Tx)	TD
#4 Data Terminal Ready	DTR	→	#4 Data Terminal Ready	DTR
#5 Signal Ground/Common (SG)	GND	↔	#5 Signal Ground/Common (SG)	GND
#6 Data Set Ready	DSR	←	#6 Data Set Ready	DSR
#7 Request to Send	RTS	→	#7 Request to Send	RTS
#8 Clear to Send	CTS	←	#8 Clear to Send	CTS
#9 Ring Indicator	RI	←	#9 Ring Indicator	RI
Soldered to DB9 Metal-Shield	FGND	↔	Soldered to DB9 Metal-Shield	FGND

When connecting to a serial device, such as a display, through a matrix switch, in addition to knowing what kind of RS-232 device your PC and display are, DTE or DCE, you also have to know if the ports on your switch are DTE or DCE ports to know which cables to use.

RS-232 female ports usually indicate DCE devices, while RS-232 male ports usually indicate DTE devices, but this is not always the case.

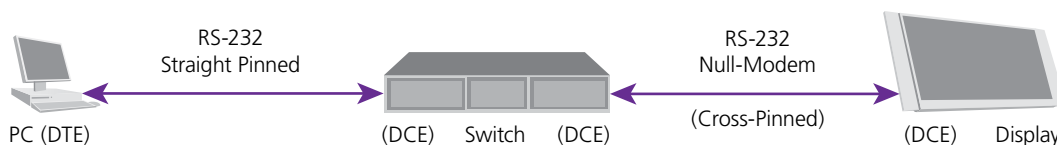

## HDBaseT Extension

HDBaseT is a connectivity standard for distribution of uncompressed HD multimedia content. HDBaseT technology converges full HD digital video, audio, 100BaseT Ethernet, power over cable, and various control signals through a single LAN cable. This is referred to as 5Play™, a feature set that puts HDBaseT technology above the current standard.

When video sources are not located close to the matrix switch, HDBaseT is the extension standard that is chosen since it delivers everything over one CATx cable.

### Video

HDBaseT delivers full HD/3D and 2K/4K uncompressed video to a network of devices or to a single device (point-to-point). HDBaseT supports all key HDMI 1.4 features, including EPG, Consumer Electronic Controls (CEC), EDID, and HDCP. The unique video coding scheme ensures the highest video quality at zero latency.

### Audio

As with the video, HDBaseT audio is passed through from the HDMI chipset. All standard formats are supported, including Dolby Digital, DTS, Dolby TrueHD, DTS HD-Master Audio.

### Ethernet

HDBaseT supports 100Mb Ethernet, which enables communications between electronic devices including televisions, sound systems, computers, and more. Additionally, Ethernet support enables access to any stored multimedia content (such as video or music streaming).

### Control

The wide range of control options for HDBaseT include CEC, RS-232, and infrared (IR). IP control is enabled through Ethernet channel support.

### Power

The same cable that delivers video, audio, Ethernet, and control can deliver up to 100W of DC power. This means users can place equipment where they want to, not just in locations with an available power source.

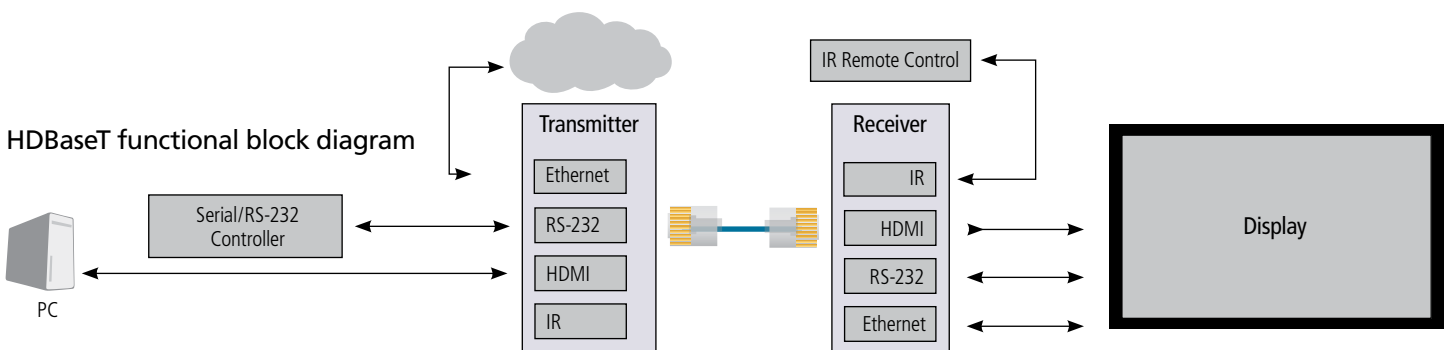

## HDBaseT Architecture

HDBaseT sends video, audio, Ethernet, and control from the source to the display, but only transfers 100 Mb of data from display to source (Ethernet and control data). The asymmetric nature of HDBaseT is based on a digital signal processing (DSP) engine and an application front end (AFE) architecture.

HDBaseT uses a proprietary version of Pulse Amplitude Modulation (PAM) technology, where digital data is represented as a coding scheme using different levels of DC voltage at high rates. This special coding provides a better transfer quality to some kinds of data without the need to "pay" the protecting overhead for the video content, which consumes most of the bandwidth. HDBaseT PAM technology enables the 5Play feature-set to be maintained over a single 330-foot (100 m) CATx cable without the electrical characteristics of the wire affecting performance.

## Matrix Switching and Video Extension: Choosing the Right Technology

For video-heavy extension over short distances, users can choose an HDMI or a DVI repeater using native cabling, or an extender kit using proprietary uncompressed technology. For mid-range applications, HDBaseT or compressed extenders may be the best choice. These can be either IP-based or use proprietary standards. For runs exceeding 400 feet, the options will either be to use fiber optic extenders, convert the signal into IP and run it over the network, or use multiple repeaters along the cable.

In collaborative environments with video extension and peripheral switching, matrix switch technology is the wave of the future. Again, the options are proprietary CATx and fiber optic cabling infrastructure or taking it to your IP network. These flexible switches extend and switch HD video and peripherals in real-time and instantaneously. Combining matrix and video extension solutions, USB extenders, and KVM setups gives users an almost endless number of configurations for their applications, from broadcast and command and control rooms, to healthcare settings, manufacturing, education, and more.

## About Black Box

Black Box is a leading ProAV and HD video and peripheral matrix switching and extension solutions provider, serving 175,000 clients in 150 countries with 200 offices throughout the world. Black Box is also known as the world's largest technical services company dedicated to designing, building, and maintaining today's complicated data and voice infrastructure systems.

© Copyright 2014. All rights reserved. Black Box® and the Double Diamond logo are registered trademarks of BB Technologies, Inc. Any third-party trademarks appearing in this white paper are acknowledged to be the property of their respective owners.